

LGX SPLICE CASSETTE - MP3SPxx



Browse on Mobile

 Browse on Web

NEXCONEC[®] LGX splicing modules allow users to fusion splice micro cables, loose-tube cables or ribbon cables to factory assembled pigtails. For up to 24 splices in LC configuration or 12 in SC. The splice clip is interchangeable allowing different splice protectors to be integrated such as heat-shrink, ribbon or sandwich (ANT) type.

FEATURES

- ✓ Conform to IEC, EIA-TIA, and Telcordia performance requirements
- ✓ Shuttered dust proof LC adapters
- ✓ Available in standard Single mode and Multimode fiber options
- ✓ Up to 24 fiber capacity
- ✓ Single and Ribbon Fiber splice
- ✓ RoHS, REACH & SVHC compliant, Materials Conflict compliant

APPLICATIONS

- ✓ Telecommunication networks
- ✓ Data centers, Co-location DC
- ✓ LAN or Campus wide Network
- ✓ Broadband network

SPECIFICATIONS

Footprint	LGX
Material	PC+ABS
Housing Color	Black
Application	LGX Panels, Chassis, Wall Boxes
Fiber Capacity	12FO or 24FO in LC / 12FO in SC
Splice Holder	40mm Heat Shrink Sleeves, Available in Crimp Style or Ribbon
Max. Cable Diameter to Use	8 mm
Dimensions (W x D x H)	130 x 154 x 30 mm
Weight Kg	0.25Kg

PERFORMANCE



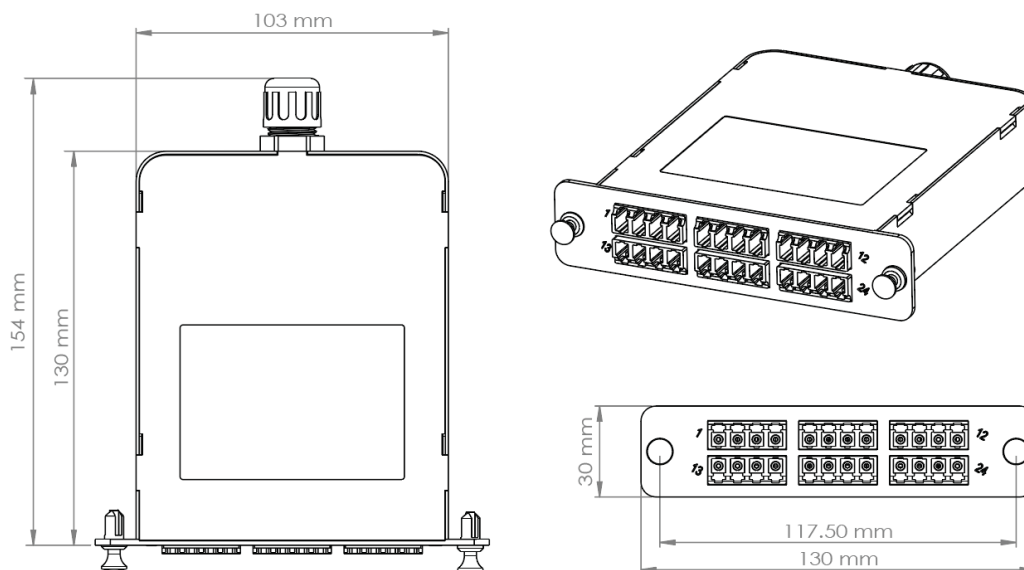

Parameters	Units	SM LC/SC	MM LC/SC
Avg/Max IL – Standard	dB	≤ 0.20/0.30	≤ 0.18/0.30
Return Loss (PC/APC)	dB	≥ 60/65	NA
Avg/Max IL– Premium	dB	≤ 0.12/0.15	≤ 0.12/0.15
Return Loss (PC/APC)	dB	≥ 60/65	NA

TECHNICAL DRAWINGS





ORDER INFORMATION

Product	Part Number	Product Description
	MP3SP01	LGX Splice Module LC 24FO Pigtailed SM
	MP3SP02	LGX Splice Module LC/APC 24FO Pigtailed SM
	MP3SP03	LGX Splice Module LC 24FO Pigtailed MM OM3
	MP3SP04	LGX Splice Module LC 24FO Pigtailed MM OM4
	MP3SP05	LGX Splice Module SC 12FO Pigtailed SM
	MP3SP06	LGX Splice Module SC/APC 12FO Pigtailed SM
	MP3SP07	LGX Splice Module SC 12FO Pigtailed MM OM3
	MP3SP08	LGX Splice Module SC 12FO Pigtailed MM OM4

	MP3SP09	LGX Splice Module LC 12FO Pigtailed SM
	MP3SP10	LGX Splice Module LC/APC 12FO Pigtailed SM
	MP3SP11	LGX Splice Module LC 12FO Pigtailed MM OM3
	MP3SP12	LGX Splice Module LC 12FO Pigtailed MM OM4

- Notes: Ribbon splice and sandwich (ANT) type are available on request.
- Add '-R' for **Ribbon Pigtailed** at the end of Part Number. (Example: MP3SP01-R)
- Add '-FT' for **France Telecom** color coding at the end of Part Number. (Example: MP3SP01-FT)

RELATED PRODUCTS AND ACCESSORIES

Product	Part Number	Product Description
	MP3PP01	1U 19" 3 Slots LGX Modular Rack Mount Enclosure Unloaded
	MP3PP02	2U 19" 6 Slots LGX Modular Rack Mount Enclosure Unloaded
	MP3PP03	4U 19" 12 Slots LGX Modular Rack Mount Enclosure Unloaded

	MP3PP04	1U 19" 3 Slots LGX Modular Sliding Patch Panel Unloaded (No Front Management)
	MP3PP05	1U 19" 3 Slots LGX Modular Sliding Patch Panel Unloaded (Including Front Management)
	MP3PP06	1U 19" 3 Slots LGX Modular Fixed Frame Unloaded (No Front Management)
	MP3PP07	1U 19" 3 Slots LGX Modular Fixed Frame Unloaded (Including Front Management)
	LGX3U	3U 19" 14 Slots LGX Modular Fixed Frame Unloaded (Including Front Management)
	FW1MP3	1 Slot LGX Wall Mount Modular Box Unloaded
	FW2MP3	2 Slot LGX Wall Mount Modular Box Unloaded
	FW4MP3	4 Slot LGX Wall Mount Modular Box Unloaded